

Tools required for installation



Electric drill



Drill bit
(Φ6)



Tape measure
(3m~5m)

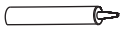

Silicone



Pencil



Screwdriver

Cabinet



6A



7B

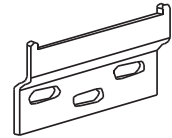

2D



1E

1

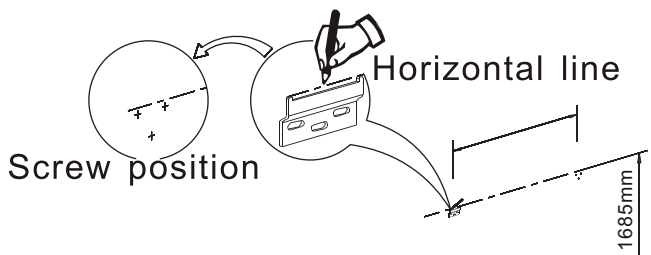

2

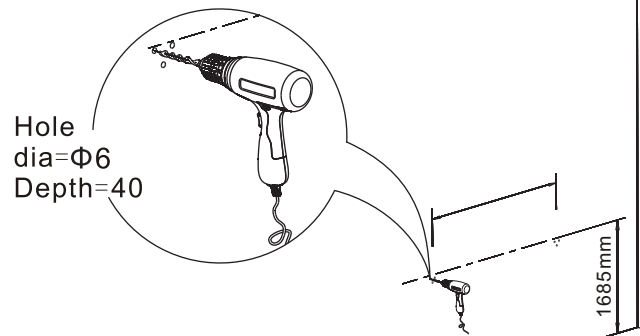

3

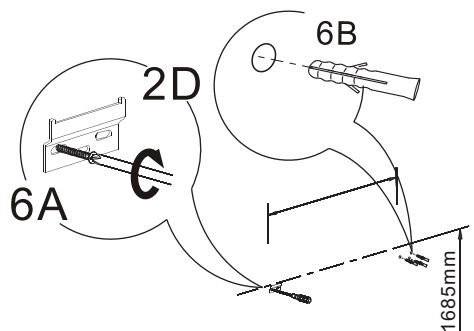

4

