

Instruction and Care Guide

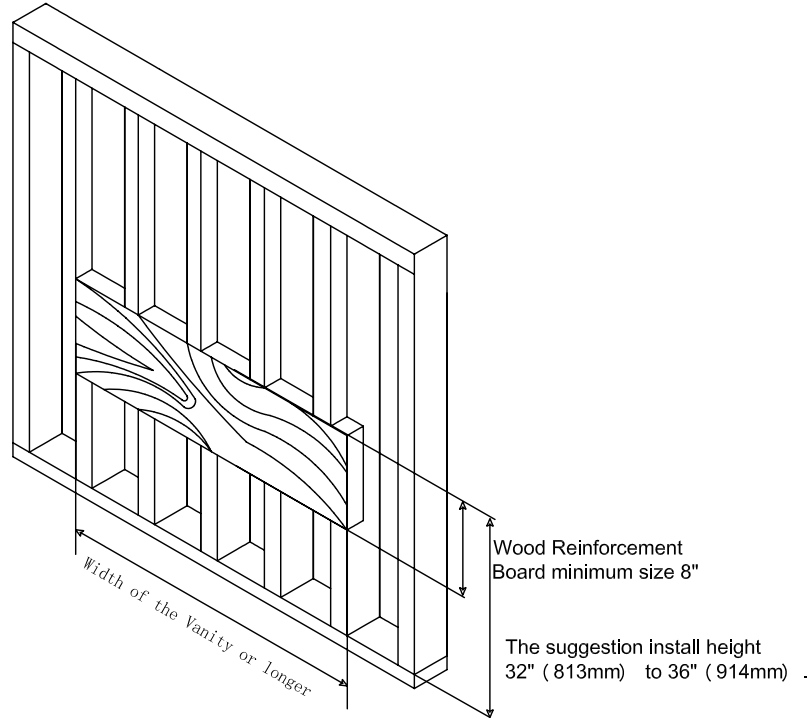

Wall blocking is required for all installation

The typical dimensions shown will result in vanity cabinet height of 34-1/4" (870mm) .
 Depending on the sinks selected, the total height will vary from 35" (890mm) 37-3/8 (950mm) .
 If an alternate height is desired, adjust the rough-in and backing material heights using the dimensions provided.



ITEM NO.: IC3537

Hardware

NO.	Draw	QTY
A		2
B		2
C		2
D		4

Tools

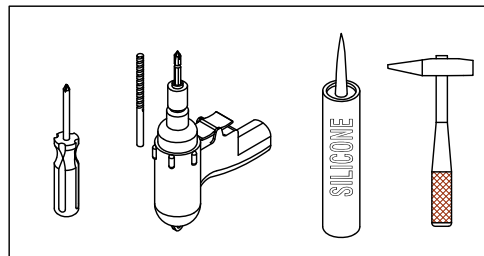

Step 1

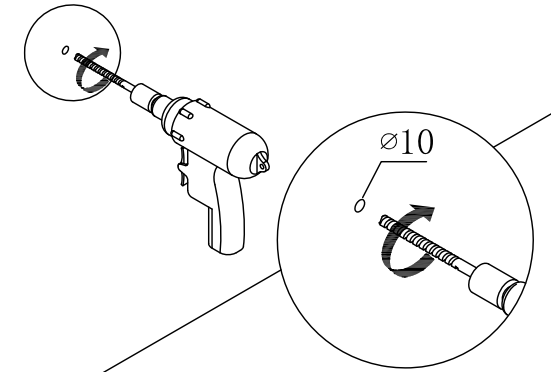

Step 2

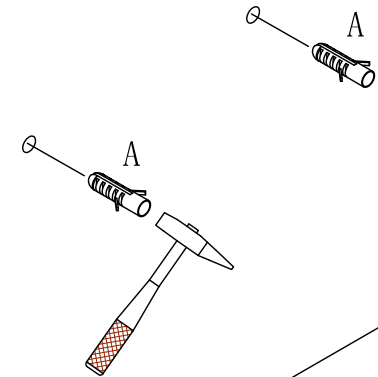

Step 3

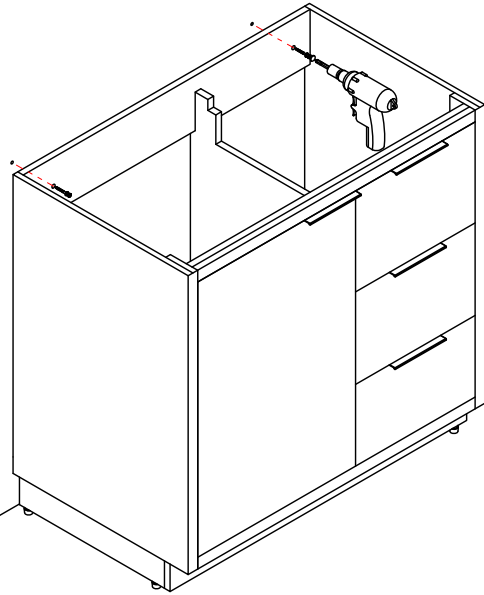

Finished

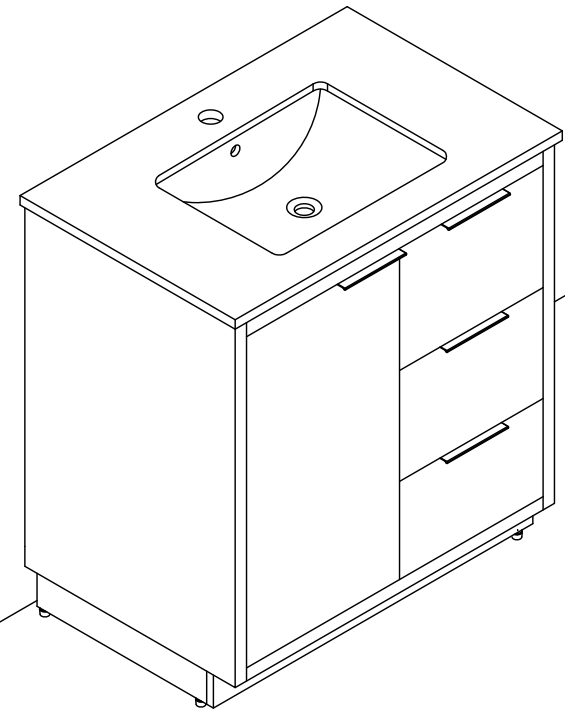

Step 4

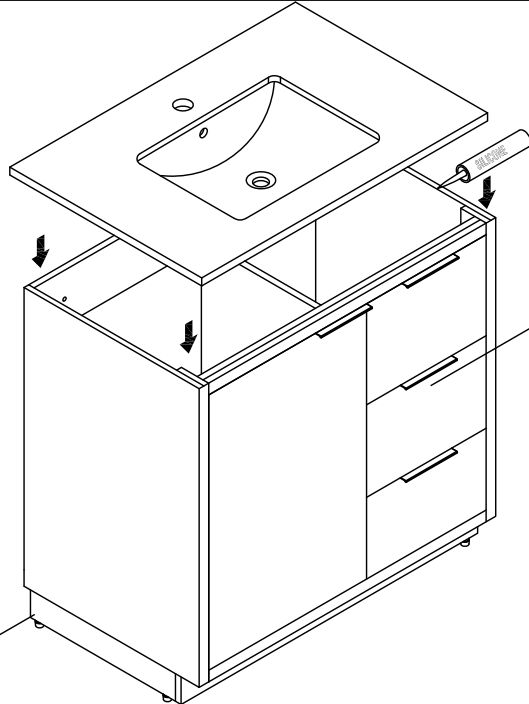

DRAWER REMOVAL & INSTALLATION

REMOVAL

1. Full pull out the drawer.

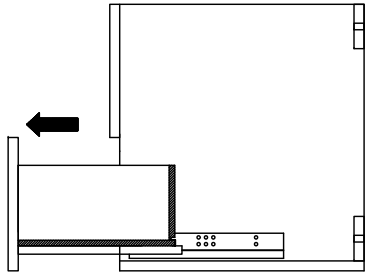

2. Pull out the bottom of the rail plastic insert

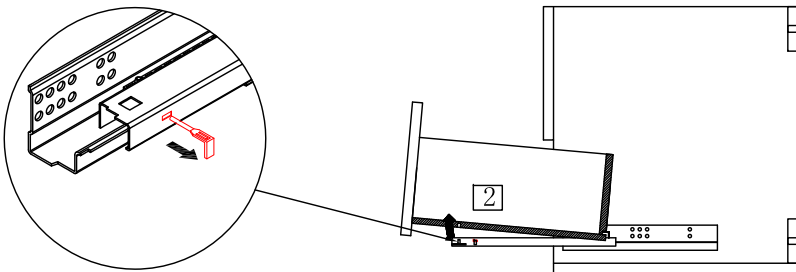

3. Finally pull out the drawer.

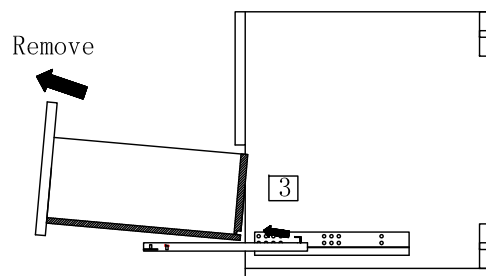

INSTALLTION

1. Pull the drawer rail, rail socket holes at the back of the drawer.

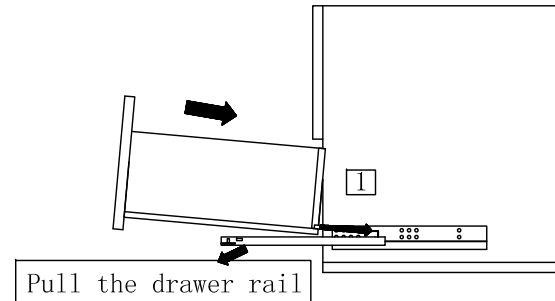

2. Plastic insert for drawer side hole.

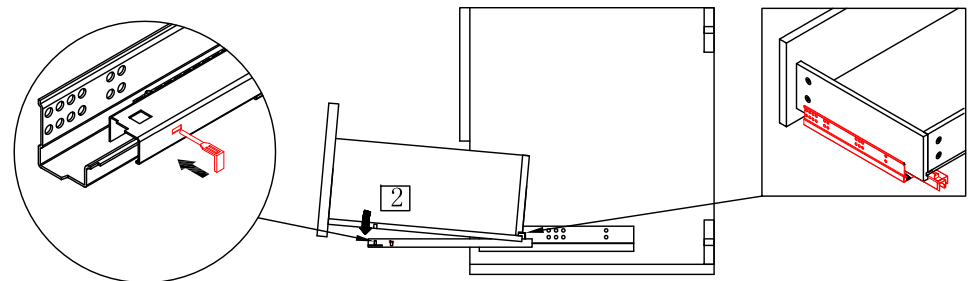

3. Push the drawer.

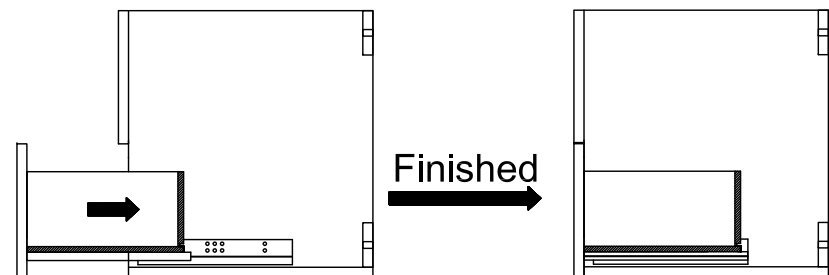



INOLAY takes great pride in the durability of its products, using materials and finishes designed to endure day-to-day use, and withstand the ever-changing humidity and temperature levels of bathroom environments. We recommend the following care instructions for your new furniture:

- 1) Only cleaning products specifically designed for furniture should be used, such as Pledge (we highly recommend Pledge Multisurface Cleaner).
- 2) Soft cleaning products such as microfiber clothes may be used, but harsh or abrasive materials will damage the surface finish or remove the sealants. No bleach - or ammonia-based products should be used.

For questions, please call our customer service center at 1-855 472 4304.